

SECTIONS

BOTTOM VIEW

Solid Bottom

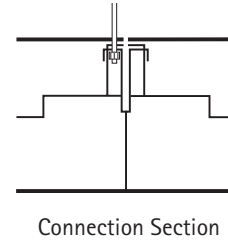
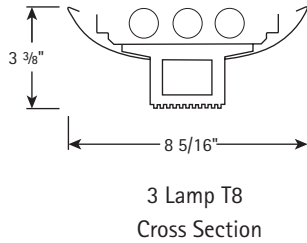
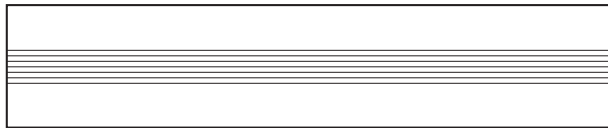
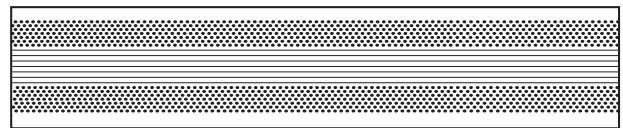
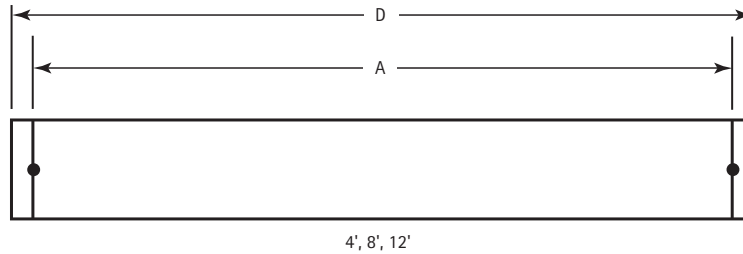
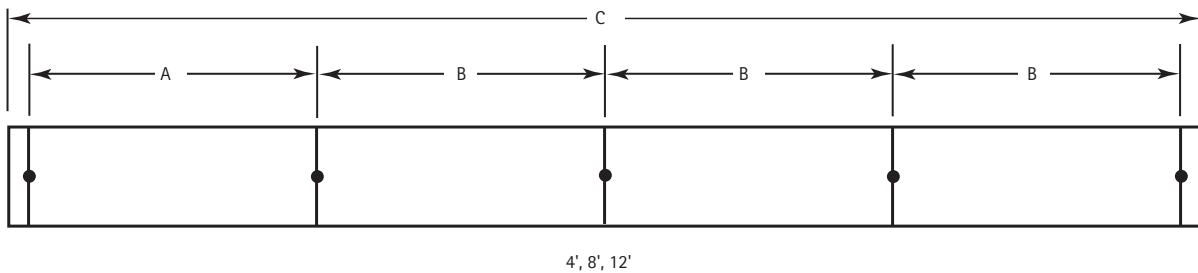

Perforated Bottom

SINGLE MOUNTING

ROW MOUNTING

DATA CHART

Nominal Length	Approx. Weight			A	B	C	D
	1-lamp	2-lamp	3-lamp				
4'	10 lbs.	10 lbs.	10 lbs.	47 1/2"	48"	193"	49"
8'	20 lbs.	20 lbs.	20 lbs.	95 1/2"	96"	385"	97"

Note: Suspension data is computed using the standard aircraft cable assembly. The use of rigid stems will yield different data. Please consult factory for stem data.

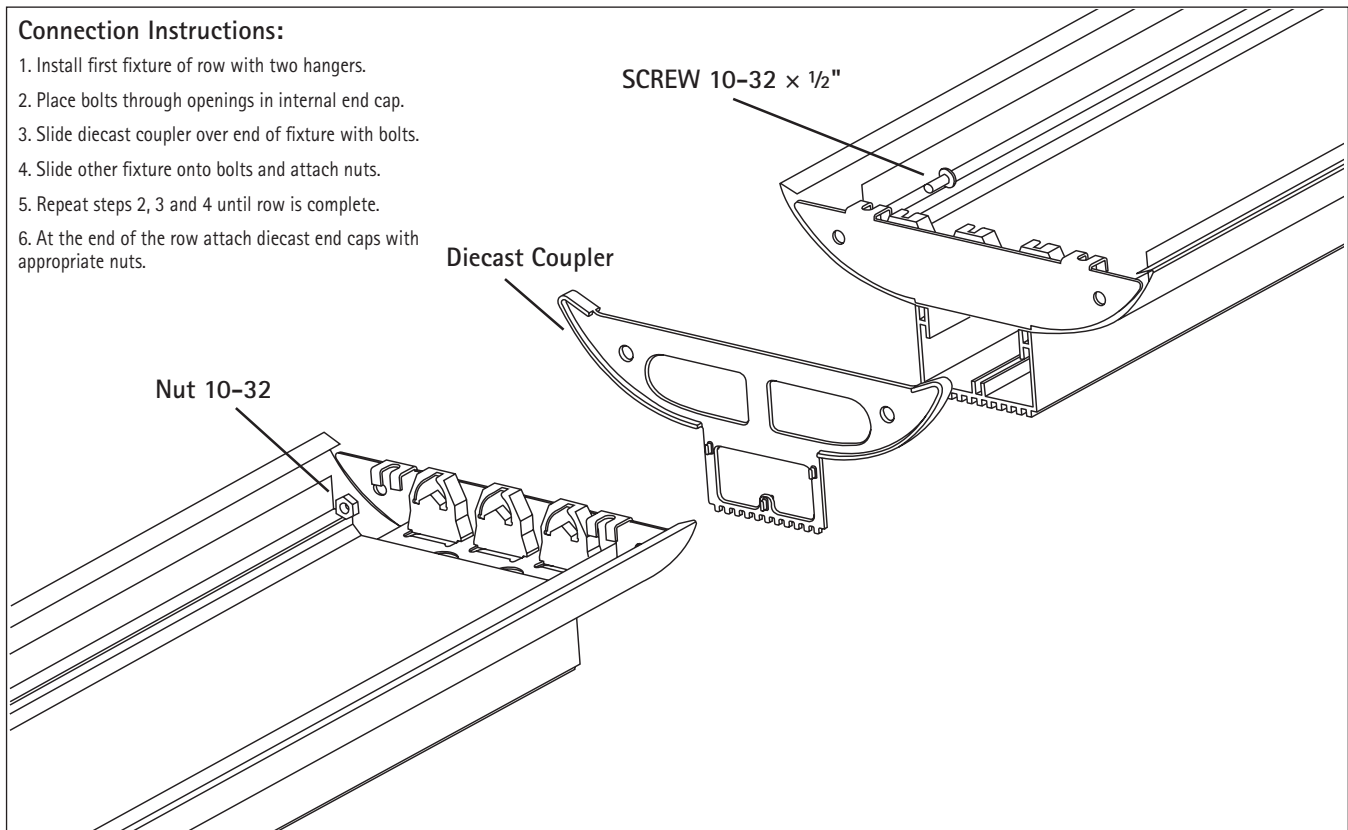
Connection Instructions:

1. Install first fixture of row with two hangers.
2. Place bolts through openings in internal end cap.
3. Slide diecast coupler over end of fixture with bolts.
4. Slide other fixture onto bolts and attach nuts.
5. Repeat steps 2, 3 and 4 until row is complete.
6. At the end of the row attach diecast end caps with appropriate nuts.

Suspension Instructions:

1. Set bottom nut to desired fixture height.
2. Slide cable hanger into hanger slot.
3. Secure and tighten upper nut.
4. Push plunger down to adjust cable to proper suspension. Cut excess cable.
5. For fine-tuning of fixture balance, slide knuckle across yoke. Hand tighten cable gripper to lock in place.

