

SECTIONS

Cross Section

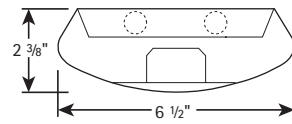
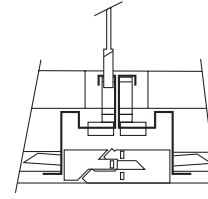
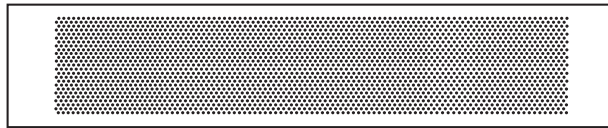

Connection Section

BOTTOM VIEW

All Perforated Bottom

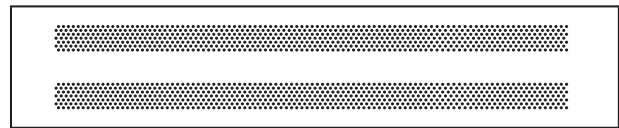

Perforated Bottom

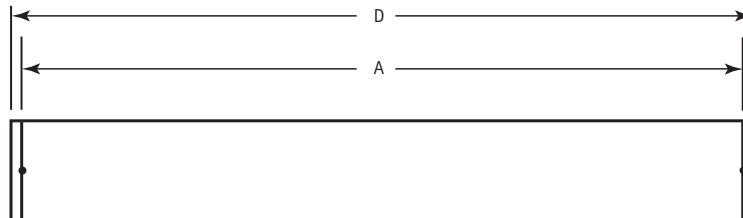
SINGLE MOUNTING

4, 8, 12 ft. Single

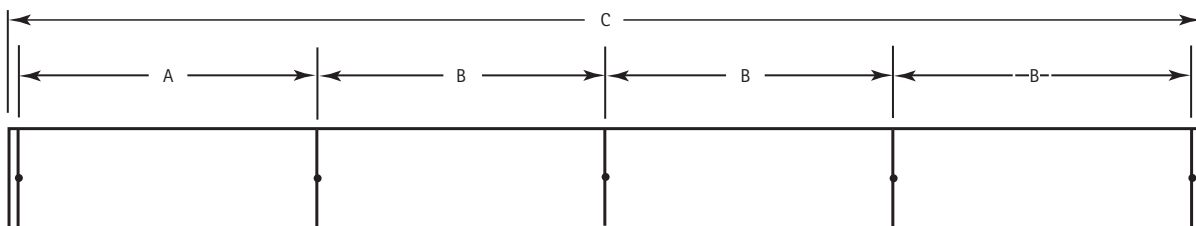
ROW MOUNTING

4, 8, 12 ft. Rows

DATA CHART

Nominal Length	Approx. Weight			A	B	C	D
	1-lamp	2-lamp	3-lamp				
4'	10.5 lbs.	11.2 lbs.	12.5 lbs.	47 1/2"	48"	192 1/8"	48 1/8"
8'	21.0 lbs.	22.4 lbs.	25.0 lbs.	95 1/2"	96"	384 1/8"	96 1/8"
12	31.5 lbs.	33.6 lbs.	37.5 lbs.	143 1/2"	144"	576 1/8"	144 1/8"

Note: Suspension data is computed using the standard aircraft cable assembly. The use of rigid stems will yield different data. Please consult factory for stem data.

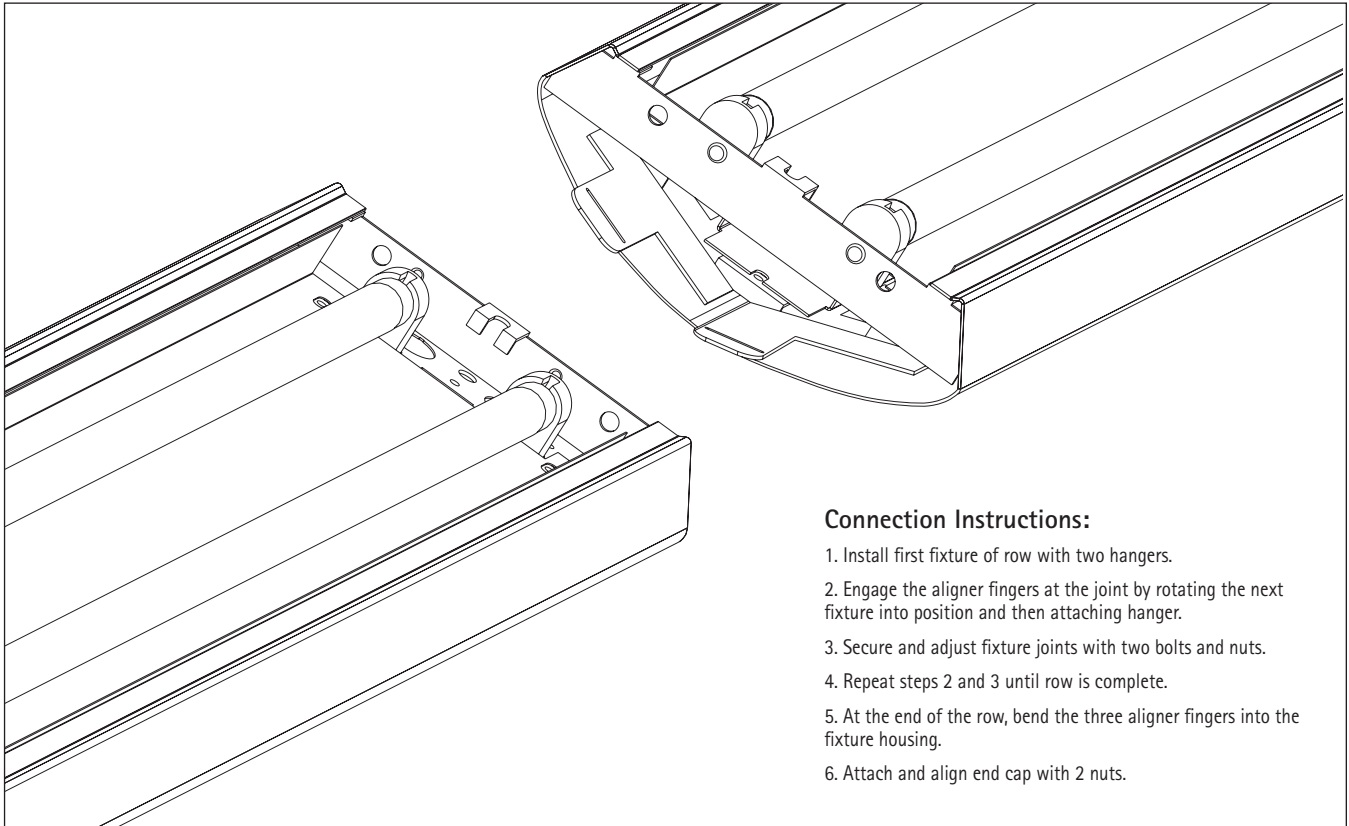
Connection Instructions:

1. Install first fixture of row with two hangers.
2. Engage the aligner fingers at the joint by rotating the next fixture into position and then attaching hanger.
3. Secure and adjust fixture joints with two bolts and nuts.
4. Repeat steps 2 and 3 until row is complete.
5. At the end of the row, bend the three aligner fingers into the fixture housing.
6. Attach and align end cap with 2 nuts.

Suspension Instructions:

1. Set bottom nut to desired fixture height.
2. Adjust upper nut for a minimum of 3/8" between upper and lower nuts.
3. Slide cable hanger into hanger slot.
4. Secure and tighten upper nut.

