

SECTIONS

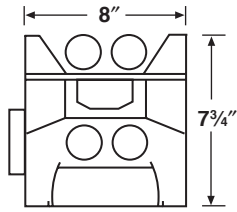

CROSS SECTION

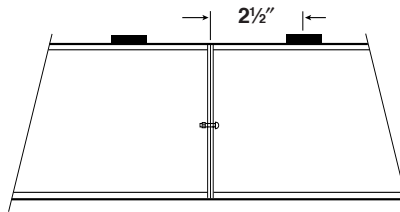

CONNECTION SECTION

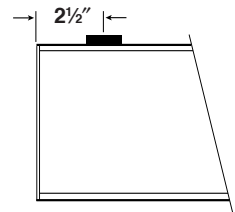

END SECTION

BOTTOM VIEW



SINGLE

SINGLE MOUNTING (TYPICAL)

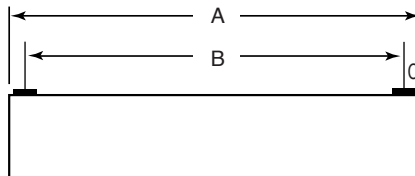

ROW MOUNTING

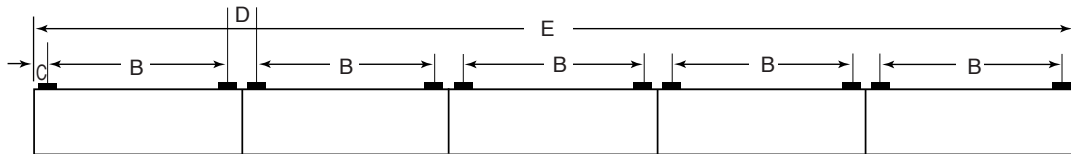

FACTORY STANDARD (TYPICAL ROW)

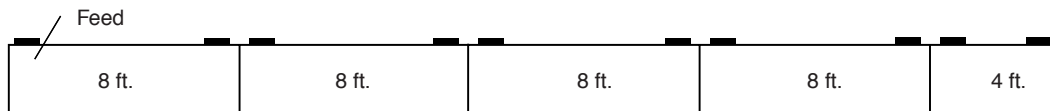

DATA CHART

Nominal Length	Weight	A	B	C	D	E
4'	26 lbs.	48"	43"	2 1/2"	5"	240"
8'	39 lbs.	96"	91"	2 1/2"	5"	480"

WALL BRACKET MOUNTING

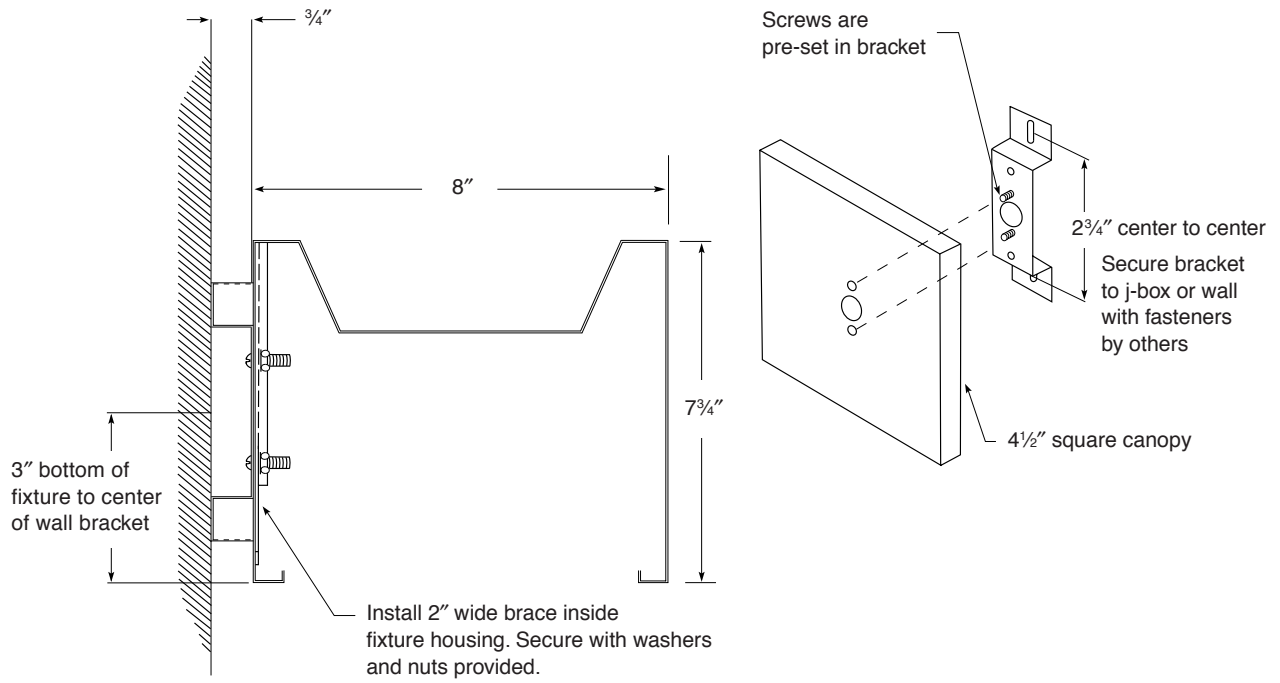

FIXTURE CONNECTIONS

