

SECTIONS

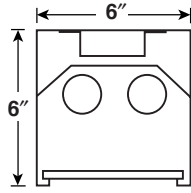

CROSS SECTION

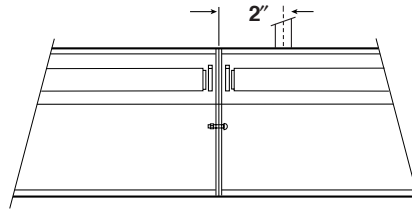

CONNECTION SECTION

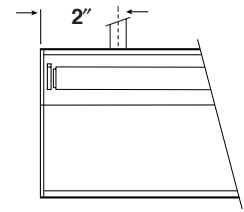

END SECTION

BOTTOM VIEW



SINGLE

SINGLE MOUNTING (TYPICAL)

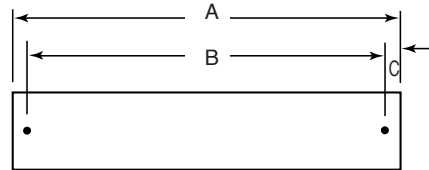

ROW MOUNTING

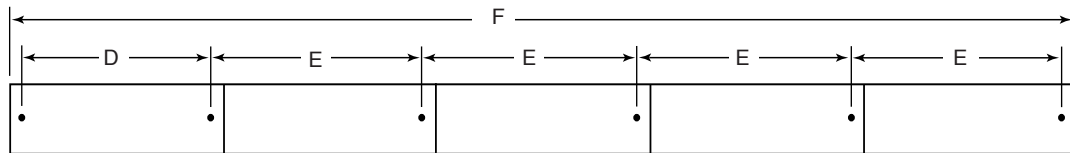

FACTORY STANDARD (TYPICAL ROW)

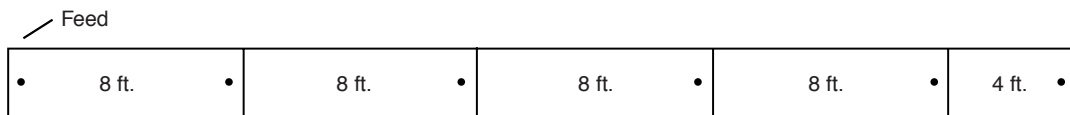

DATA CHART

Nominal Length	Weight	A	B	C	D	E	F
4'	18 lbs.	48"	44"	2"	44"	48"	240"
8'	31 lbs.	96"	92"	2"	92"	96"	480"

FIXTURE CONNECTIONS

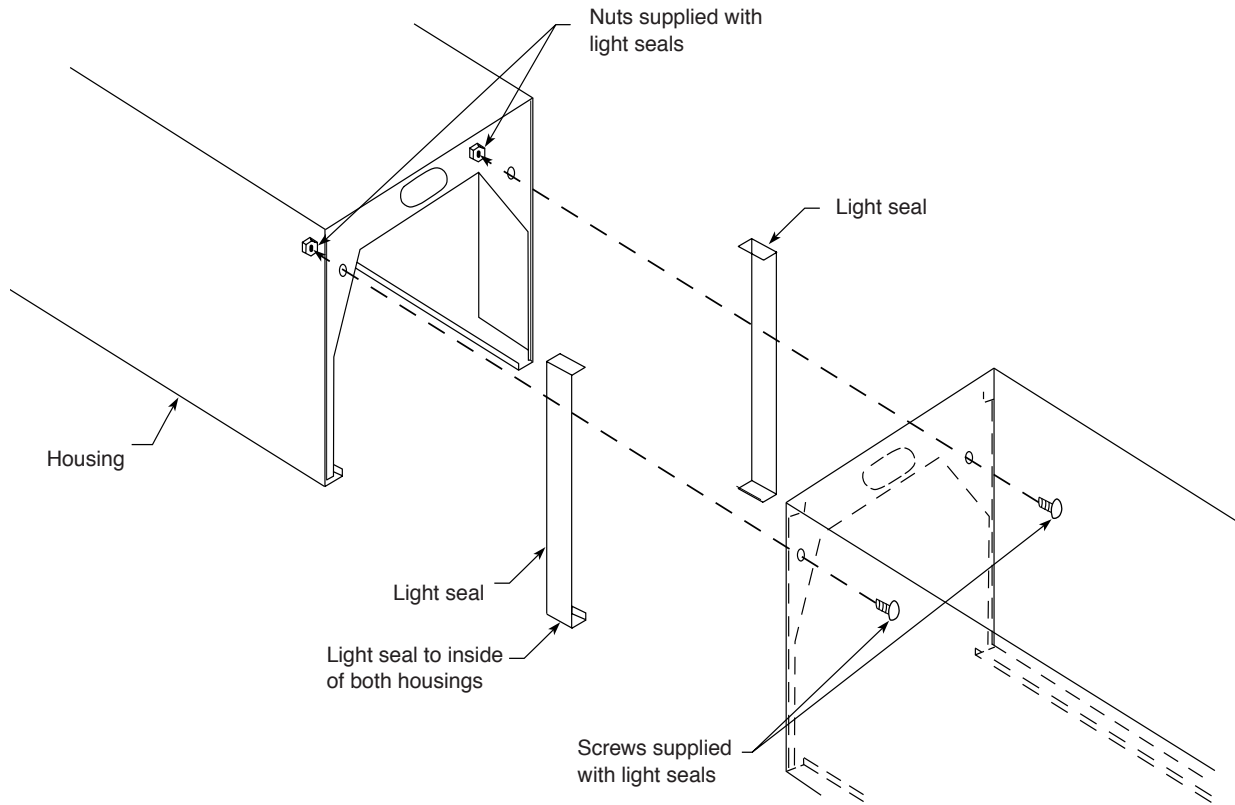

PATTERNS

8 foot pattern

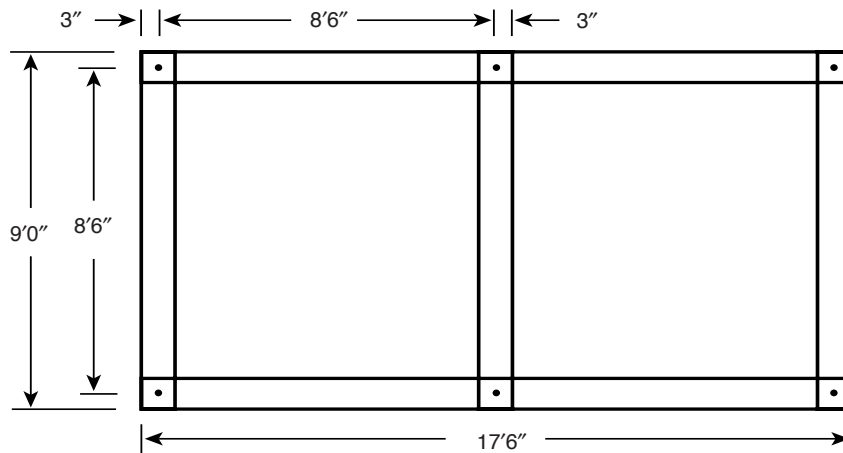

ENDCAP ATTACHMENT

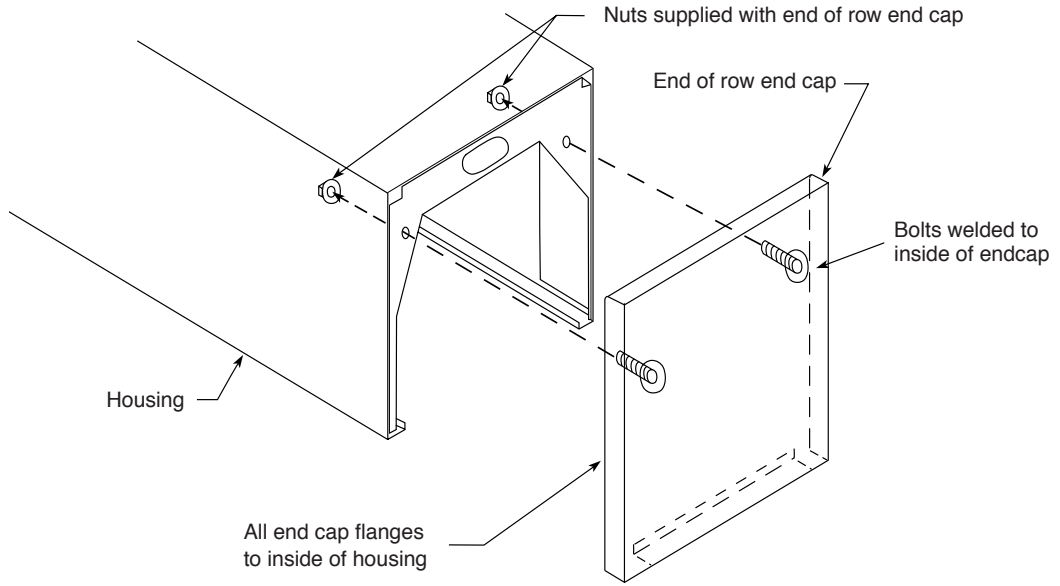

ADJUSTABLE WALL CONNECTOR

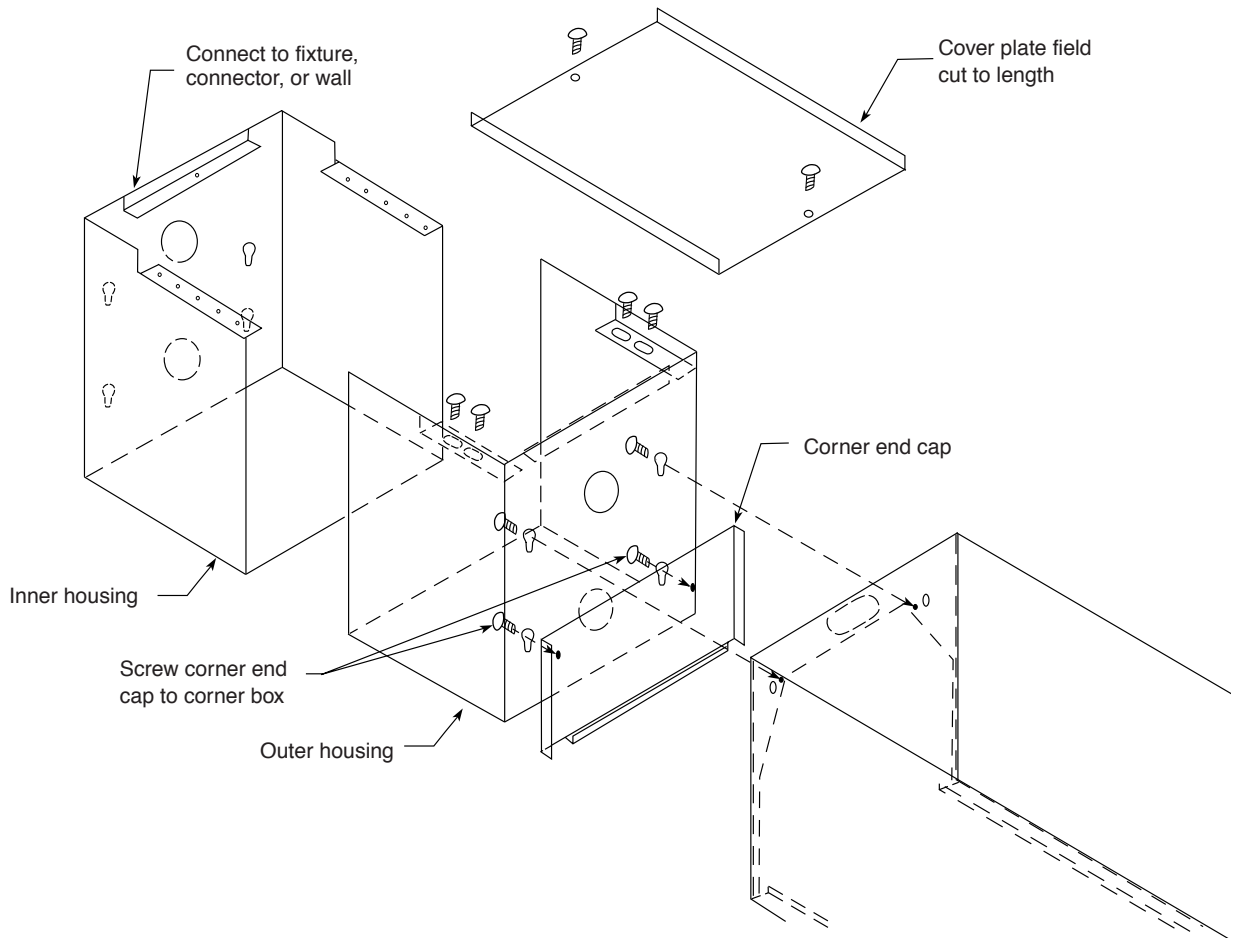

90° CONNECTOR

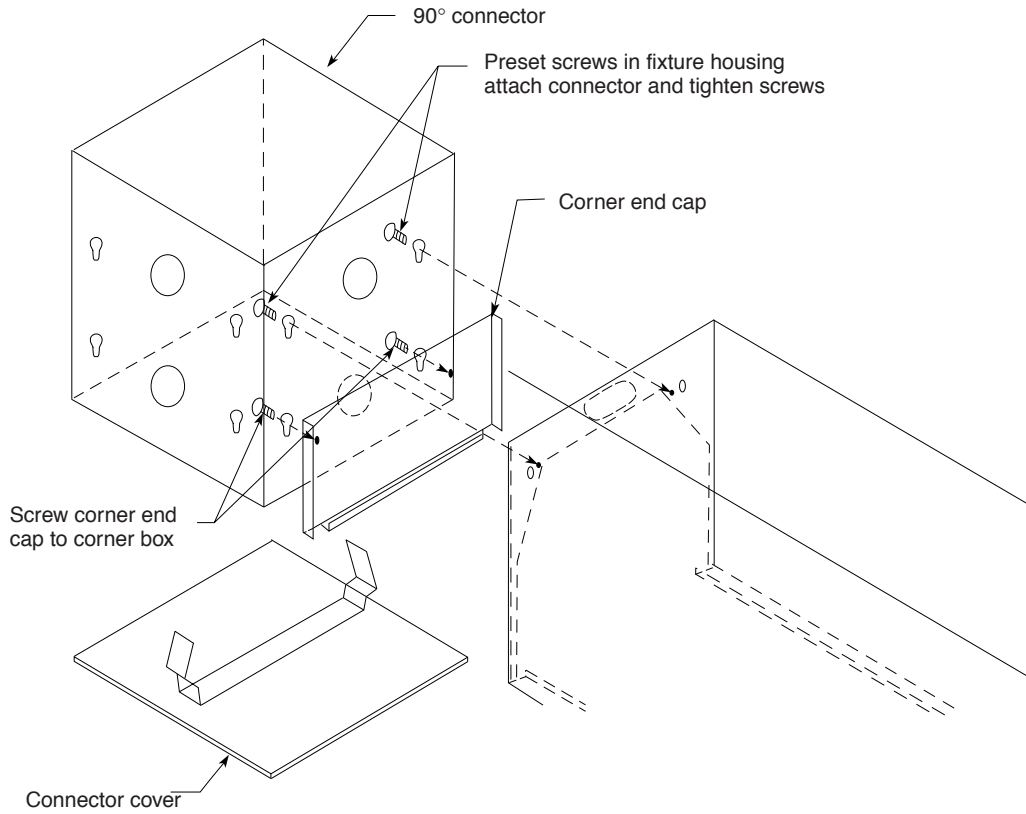

TEE CONNECTOR

