

SECTIONS

Cross Section

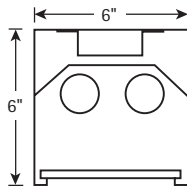

Connection Section

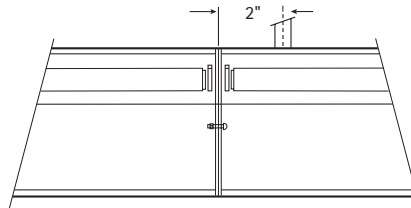
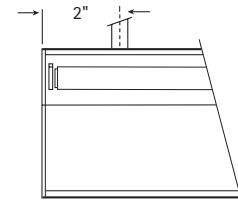

End Section

BOTTOM VIEW

Single

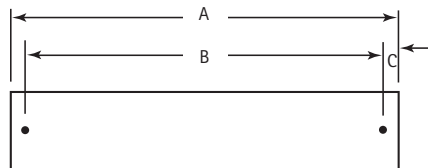
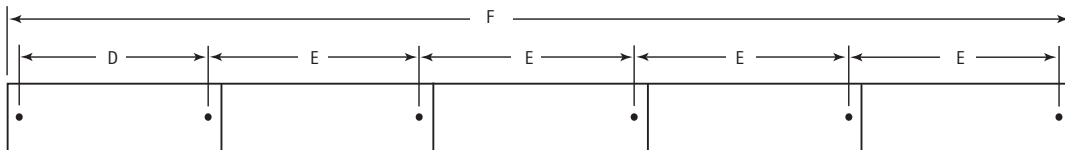
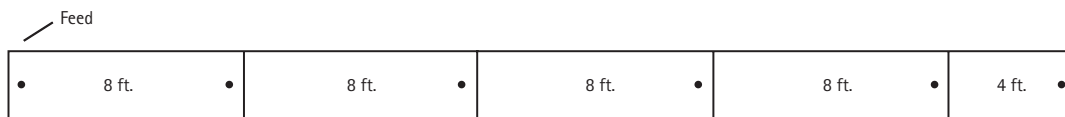
SINGLE MOUNTING (TYPICAL)

ROW MOUNTING

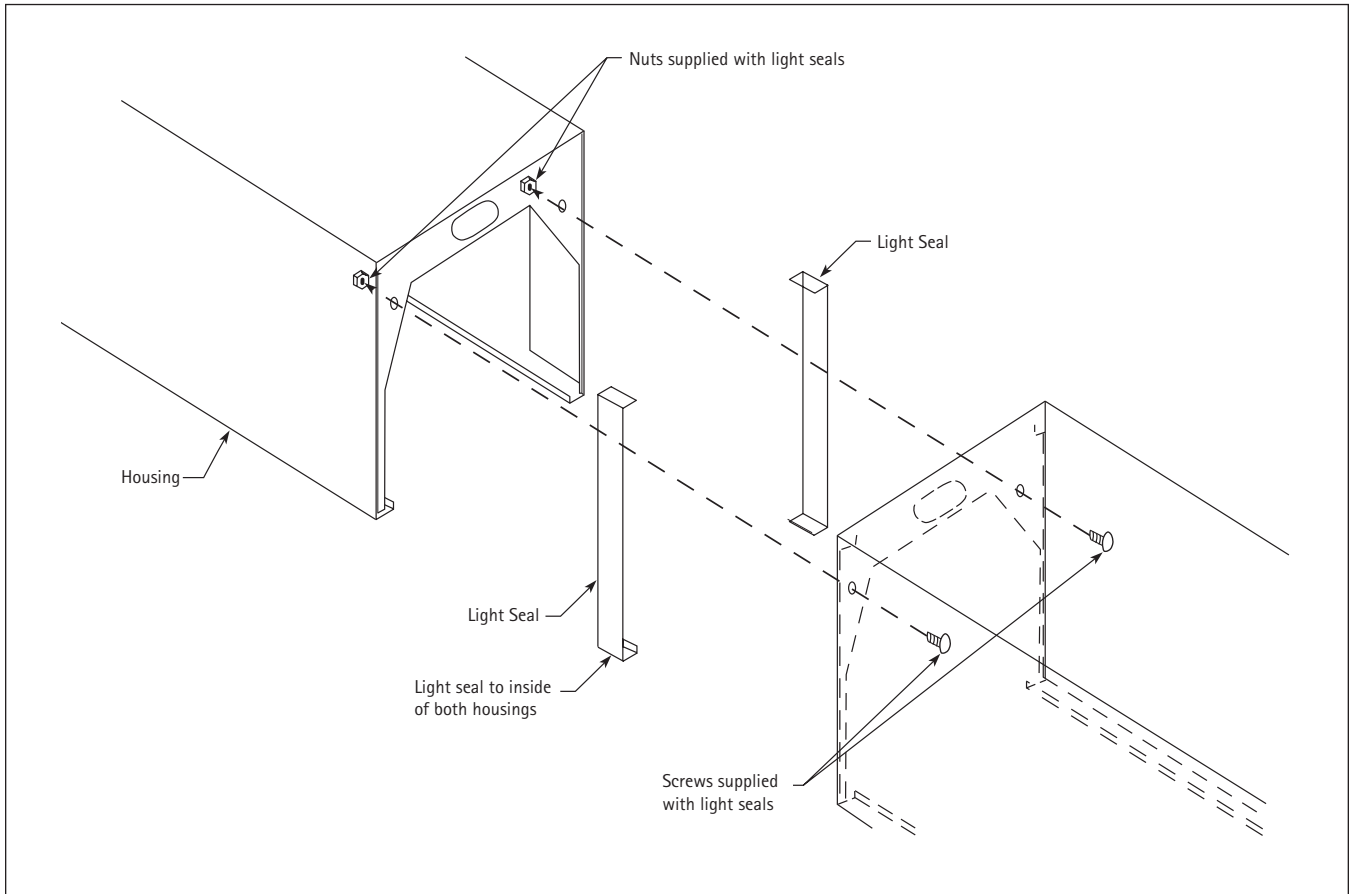
FACTORY STANDARD (TYPICAL ROW)

DATA CHART

Nominal Length	Weight	A	B	C	D	E	F
4'	18 lbs.	48"	44"	2"	44"	48"	240"
8'	31 lbs.	96"	92"	2"	92"	96"	480"



8 foot pattern

