

SECTIONS

Cross Section

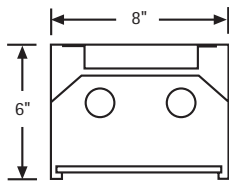

Connection Section

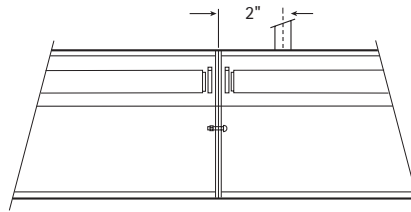
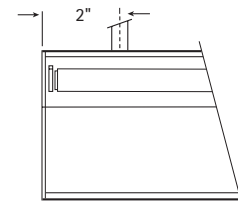

End Section

BOTTOM VIEW

Single

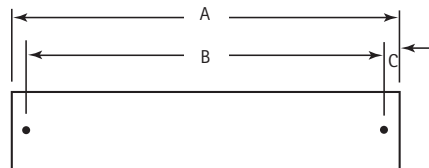
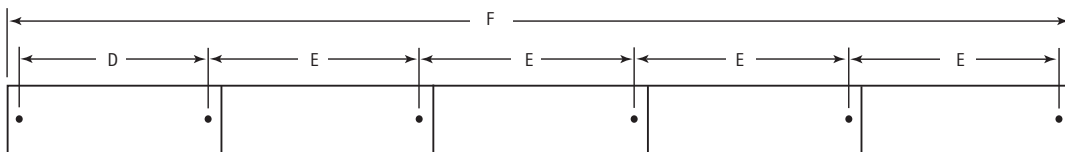
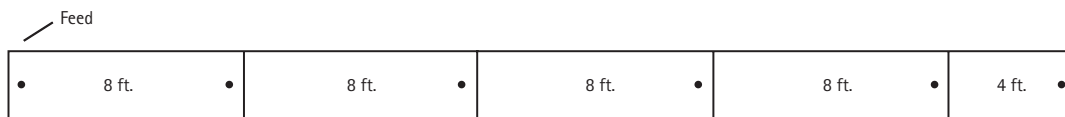
SINGLE MOUNTING (TYPICAL)

ROW MOUNTING

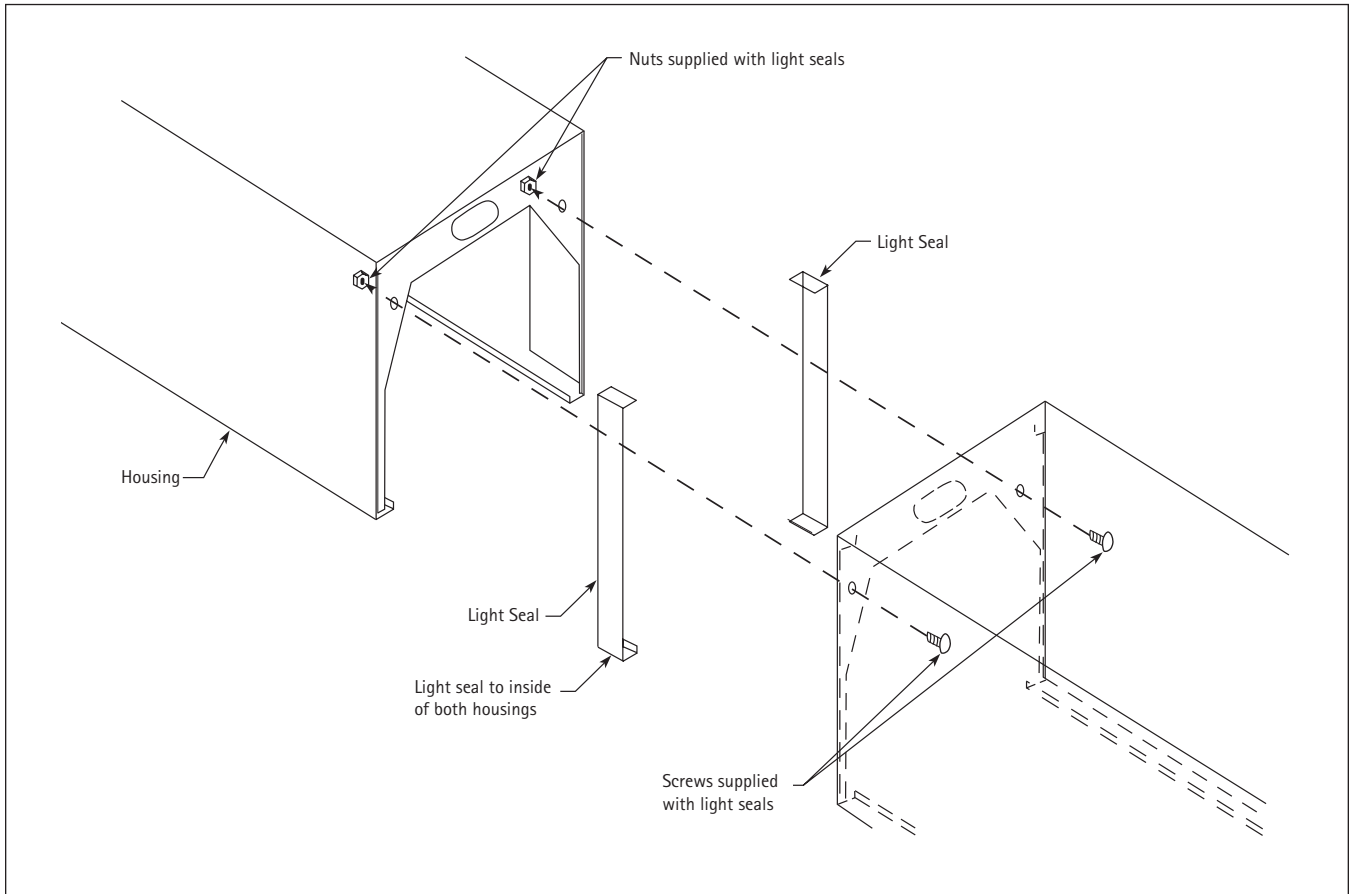
FACTORY STANDARD (TYPICAL ROW)

DATA CHART

Nominal Length	Weight	A	B	C	D	E	F
4'	23 lbs.	48"	44"	2"	44"	48"	192"
8'	36 lbs.	96"	92"	2"	92"	96"	384"



8 foot pattern

